

Series	3427.8 Series
Part Numbers	3427.8.X, 3427.8A, 3427.8S.X, 3427.8AS.X
Product Description	8 strip caps for 0.2 ml PCR tubes
Composition	Virgin polypropylene
Compatibility	Compatible with most Thermal Cycler products on the market
Packaging Breakdown	125 strips per pack/10 packs per case
Autoclavable	Autoclavable at 121°C for 15 minutes at 15 PSI
Storage Conditions	Store in a clean, dry environment at room temperature 15-30°C
Physical Data	Uniform thin wall design for optimum heat transfer Available pre-sterile, assorted colors, pre-sterile assorted colors or clear non-sterile Compatible with standard 96 well blocks DNase, RNase and pyrogen free
Production Standards and Processes	Product is assembled under a rigorous quality control system in a RNase/DNase free white room in accordance with ISO 9001:2000 standards. Biotix personnel are capped, masked, gloved and gowned in the assembly area. RNase/DNase free certification is verified for every lot as required.

3427.8 Series

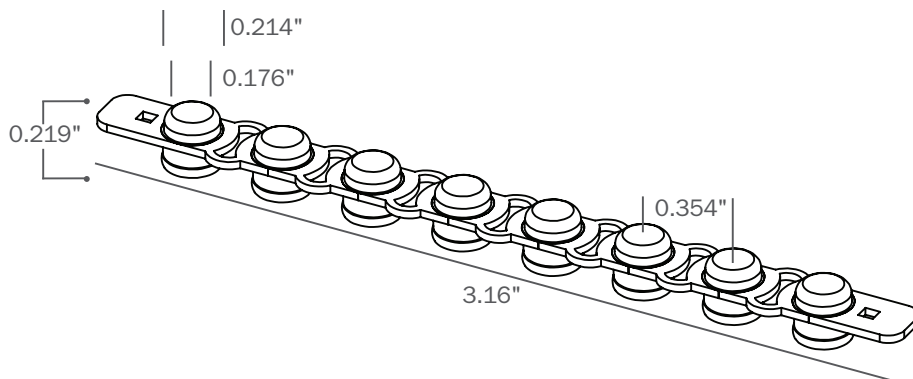



Quality Control:

Certificates of Compliance	Each lot undergoes stringent inspection and individual lot testing ensures Neptune products are certified RNase, DNase, DNA and Endotoxin-free. Visit www.neptunescientific.com to obtain a copy of a certificate of compliance for your Neptune product.
RNase/DNase	Products are washed in distilled water and concentrated via centrifugation. Samples are added to previously established nucleic acid standards, incubated for one hour at 37°C, and tested on a 2% gel using electrophoresis. Products must show no degradation of standards to pass. Test sensitivity is 10 ⁻⁷ Kunitz units/μl.
Nucleic Acid	Products are washed in distilled water and concentrated via centrifugation. Then, samples are added to protocol specified PCR reactions and thermal cycled for 50 cycles. A 2% agarose gel electrophoresis is used to examine experimental samples, positive controls, and negative controls. To pass, product samples must show no DNA amplification.
Endotoxin/Pyrogen	Products are tested for endotoxins by using the Limulus Amebocyte Lysate (LAL) gel assay according to FDA guidelines. Test sensitivity is 0.06 EU/ml.
Sterilization	Products are sterilized using electron beam irradiation.
Traceability	Each product contains a 5 digit lot number located on the rack, pack and case of each finished good. With Neptune's advanced manufacturing process all raw materials are able to be traced for maximum quality assurance.

The information is for reference only. Actual features vary slightly with each part number, please contact technical support or your local sales representative with questions. For hazard data, please refer to the MSDS for the material composition specified above.

USA 888.330.2396
INTL +1.858.875.7696

www.neptunescientific.com
csr@neptunescientific.com

NEPTUNE[™]
Tools for Life Sciences